



HVI - The World's Source For High Voltage Test Equipment



Cable Fault Locators w/TDR

Oil/Fluid Dielectric Testers

Very Low Frequency AC Technology W/TD & PD Diagnostics

**Portable AC Hipots
Higher kVA AC Test Sets**

DC Hipots & Megohmmeters

HV Divider

Aerial Lift Testers

HVI Products Are Designed to Surpass All Others in Features, Specifications, and Ease in Use



ISO 9001 2008 The World's Source for High Voltage Test Equipment **MADE IN THE USA**



Serving the HV Equipment needs of the Electric Power Industry since 1997

HVI designs and produces high voltage test equipment for the **Proof, Preventive, & Diagnostic Testing** of power cables, aerial lifts, and most electrical apparatus used in the production, transmission, & distribution of electricity. Our major markets include:

- Utilities, Power Producers, Wind and Solar Farms
- Testing Service Companies
- Motor/Transformer Repair Shops
- Electrical Contractors
- Large Industrial/Commercial Installations
- HV Electrical Apparatus Manufacturers



ISO 9001 2008 *The World's Source for High Voltage Test Equipment* **MADE IN THE USA**



Known Worldwide For Its Superior Field Test Equipment

THE HVI PRODUCT LINEUP

- Very Low Frequency (VLF) AC Technology
- VLF Withstand, Partial Discharge, & Tan Delta Diagnostics
- DC Hipot/Megohmmeter Combination Instruments
- AC Dielectric Test Equipment
- Aerial Lift Testing: Booms & Buckets
- Oil Dielectric Testing
- Thumpers: Cable Fault Locators, Radar/TDR, Pinpoint Devices
- OEM HV AC & DC Power Supplies
- Ω -Check[®] Concentric Neutral Resistance Tester



ISO 9001 2008 *The World's Source for High Voltage Test Equipment* **MADE IN THE USA**



Very Low Frequency (VLF) AC Technology 0.1 Hz. – 0.01Hz.

Two Technologies to Serve all Applications:

VLF Series: Original 1997 Patented, Oil filled HV transformer design with analog controls
Ten Models: 0 - 30 kVac to 200 kVac peak sinusoidal. 0.4 μ F – 50.0 μ F

VLF E Series: Solid state, air insulated, fully programmable with data logging & wireless
Two Models: 0 - 34 kVac & 0 - 65 kVac peak sinusoidal. 0.5 μ F – 10.0 μ F



VLF Series

VLF-E Series



ISO 9001 2008 The World's Source for High Voltage Test Equipment **MADE IN THE USA**



Very Low Frequency (VLF) HVI Designed Tan Delta

Tangent Delta (Tan δ)/Dissipation Factor/Loss Angle
Measures a Cables Insulation Integrity to Predict Life

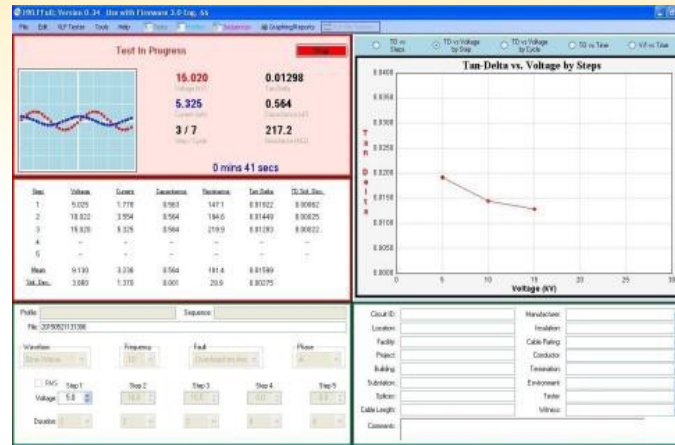
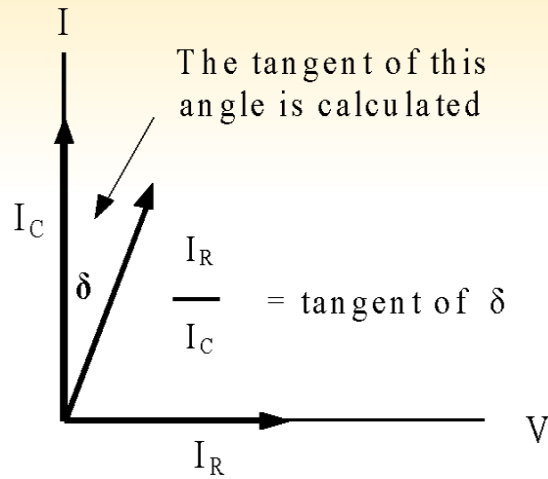

65 kV peak



34 kV peak



With the HVI *E-Link Software*

Highly praised, most comprehensive, user friendly with definable fields, XBee wireless for longer distance and more secure connections.



ISO 9001 2008 The World's Source for High Voltage Test Equipment **MADE IN THE USA**



Very Low Frequency (VLF) Diagnostic Testing Options

VLF Partial Discharge & Tan Delta 30 kVac – 200 kVac

HVI offers several packages for using any HVI VLF model for performing **Partial Discharge, PD & TD**, or just **TD** testing on cables, motors & generators, and other apparatus.

Ask HVI about which VLF and others PD/TD products will best serve your needs.

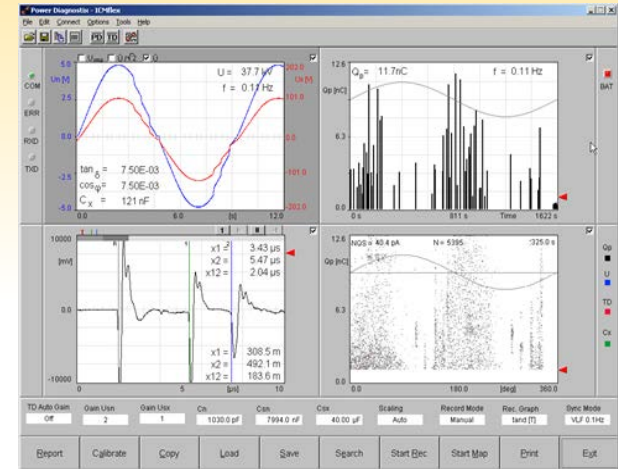

ISO 9001 2008 The World's Source for High Voltage Test Equipment **MADE IN THE USA**



DC Hipot/Megohmmeters

2 in 1. 20 - 600 kVdc @ 3 - 10 mAdc

Smaller & Lighter – Rugged & Reliable – More Full Featured

10 Models Available from

0 - 20 kVdc to 0 - 600 kVdc
5 mAdc - 10 mAdc



0 – 37.5 kVdc @ 10 mAdc



0 – 100 kVdc @ 10 mAdc



0 – 300 kVdc @ 5 mAdc



0 – 600 kVdc @ 3 mAdc



ISO 9001 2008 The World's Source for High Voltage Test Equipment **MADE IN THE USA**



PTS Series - DC Hipots

Latest Designs Offer More

The HVI Advantages

- ❑ Built in +/- 1% input line regulator to stabilize input power, permitting more accurate leakage current readings (PTS-37.5 and PTS-75 models)
- ❑ Rugged, transit protected meters. Glass fronts prevent static buildup
- ❑ Meter reads leakage current & megohms
- ❑ Guard/Ground circuit
- ❑ Rugged custom cases with cushion grips
- ❑ Smaller size and weight

❑ **Note: Steel HV Tanks are Grounded**

Common Front Panel

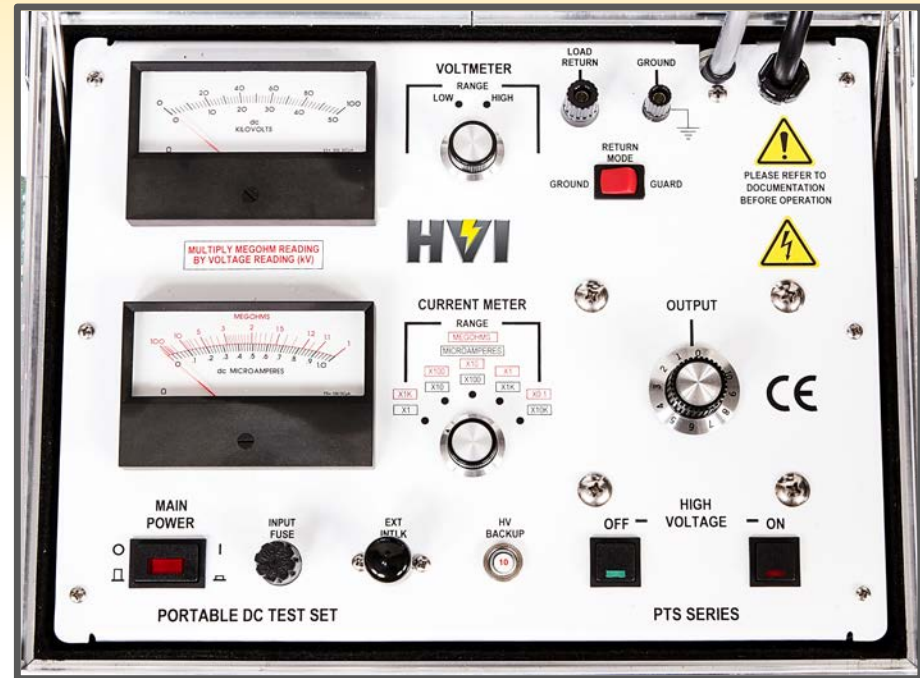

ISO 9001 2008 The World's Source for High Voltage Test Equipment **MADE IN THE USA**



Cable Fault Locators

Controlled Energy, High Burn Current,
High Joules, Internal TDR Filter



THUMPERS/SURGE GENERATORS

0 – 5/10/20 kV @ 1000 J, 400 mA Burn

0 – 9/18/36 kV @ 1600 J, 280 mA Burn

0 – 9/18/32 kV @ 3200 J, 280 mA Burn

← VLF/THUMPER COMBO MODEL

VLF Hipot: 0 – 33 kVac @ 1 uF, 0.1 Hz. peak

VLF Burner: Maintains arc every ½ cycle

Thumper: 0 – 13 kV @ 760 J every 10 secs

TDR/Radar: Built in TDR Filter

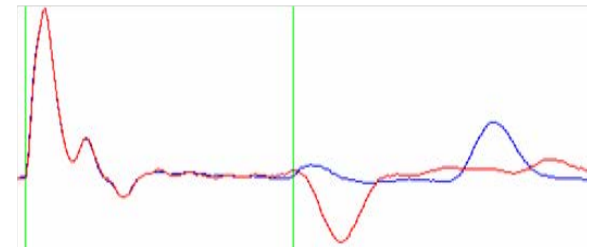

ISO 9001 2008 The World's Source for High Voltage Test Equipment **MADE IN THE USA**



Cable Test & Fault Locate Van

HVI Makes it Quick & Easy

① Select your cable testing and fault locating tools, cable reels, accessories, etc....

VLF AC Hipot:	Models from 30 kVac – 90 kVac @ 0.1 Hz.
DC Hipot:	37.5 kVdc – 200 kVdc
Thumper:	5/10/20 kV @ 1000J or 9/18/36 kV @ 3200J
TDR/Radar:	Arc Reflection & Current Impulse Locating
Listening Device:	Acoustical and Electro-Magnetic/Ballistic
Cable Reels:	Two - HV and Ground Cables, 100' (30m)
Aluminum Base:	Temporary Install or Mounted Designs

② Select your skid design and mounting method

Dimensions, fork truck portable or permanent mount

③ HVI will deliver your instant cable test package

In 6 – 8 weeks your cable trouble truck package will arrive



ISO 9001 2008 The World's Source for High Voltage Test Equipment **MADE IN THE USA**



AC Hipots & Dielectric Test Sets

Portable - Transportable - Factory Installed

HVI has developed a comprehensive line of AC Dielectric Test Sets.

Many models are low in PD output and can be ordered with PD and TD/PF measurement accessories.

Available are models from 1 kVA to 250 kVA: portable field test and substation test models, to larger field transportable models to factory installed systems for the OEM, to Resonant Sets for high capacitance loads like motors and generators.

- 1 - 3 kVA Portable AC Hipots**
- 5 - 15 kVA Field Portable AC Testers**
- 3 - 40 kVA AC Field/Factory Dielectric Testers**
- 50 - 250 kVA Parallel Resonance Supplies**



ISO 9001 2008 *The World's Source for High Voltage Test Equipment* **MADE IN THE USA**



AC Portable Hipots

Smallest, Lightest, with Higher Power

8 Models Available

0 - 10 kVac to 100 kVac

1 kVA – 3 kVA



0 – 30 kVac @ 1 kVA



0 – 30 & 50 kVac @ 3 kVA



0 – 65 kVac @ 2 kVA



0 – 40 kVac @ 1 kVA, CE



0 – 30 kVac @ 2 kVA, CE



0 – 100kVac @ 3 kVA



ISO 9001 2008 The World's Source for High Voltage Test Equipment **MADE IN THE USA**



AC Portable Hipots PFT Series

1 – 3 kVA @ 10 – 100 kVac



Analog Versions



Advantages

- 0 - 50 kVac @ 3 kVA with 120V Input ^v
- Only Single Piece Unit ^v
- 18' (6m) Shielded Cable Output ^v
- Guard/Ground Circuit
- Input Inductive Compensation
- Rugged & Reliable
- Anti-Static Glass Front Meters
- Easily Serviced
- Thousands Shipped



Digital Versions



ISO 9001 2008 The World's Source for High Voltage Test Equipment **MADE IN THE USA**



AC Dielectric Test Systems Higher Power & Higher Voltage

3 kVac – 300 kVac up to 40 kVA

Multiple Control Options

Low PD Output



ISO 9001 2008 *The World's Source for High Voltage Test Equipment* **MADE IN THE USA**



Parallel Resonance Technology

Large Motor/Generator & Apparatus Testing

AC Test High Capacitance Loads with less Power, Current, & Expense

Typical Generator Test Models

0 - 8/16 kVac @ 80 kVA

0 - 16/32 kVac @ 160 kVA

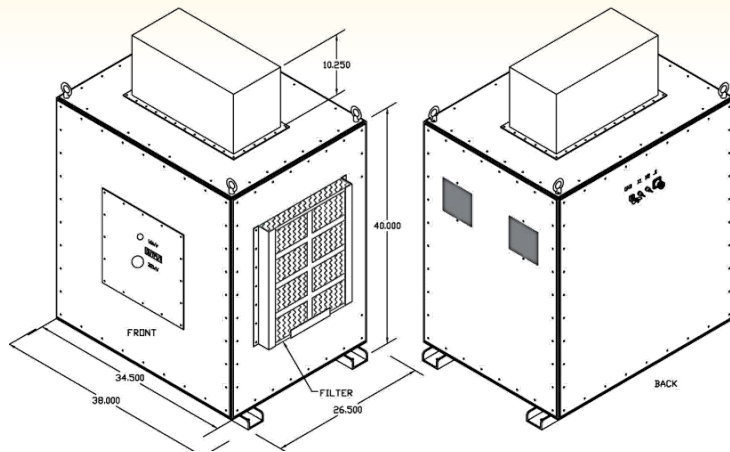

Models available to 100 kVac & 250 kVA

- ✓ AC Withstand
- ✓ Partial Discharge
- ✓ Power Factor
- ✓ Tan Delta



Model: PAR 50-250FC5

0 - 50 kVac @ 5 A, 250 kVA Load



ISO 9001 2008 The World's Source for High Voltage Test Equipment **MADE IN THE USA**



Aerial Lift Testing - AC & DC

Booms - Liners - Fluids

HVI supplies *hundreds* of various
AC & DC aerial lift testers a year

DC



100 kVdc @
10 mAdc

50 kVac @ 10 kVA
Liner Tester

AC



210/50 kVac @ 7 kVA

AC



120/60 kVac
@ 7 kVA

AC



300 kVac @ 7 kVA

AC



ISO 9001 2008 The World's Source for High Voltage Test Equipment **MADE IN THE USA**



Oil Dielectric Testers

Semi & Fully Automatic

DTS Series: Semi Automatic
60 kVac & 100 kVac



DTS A Series: Fully Automatic
w/Printer, 60 kVac & 100 kVac



ISO 9001 2008 *The World's Source for High Voltage Test Equipment* **MADE IN THE USA**



AC/DC HV Dividers 150 kV & 300 kV



Connect to any DVM



ISO 9001 2008 *The World's Source for High Voltage Test Equipment* **MADE IN THE USA**



Ω -Check[®] Concentric Neutral Resistance Tester



How are your Neutrals?

Tests While Cables Energized

Measures Neutral Corrosion

Easy to Set Up

Easy to Operate

Easy to Interpret

Test Substation
Ground Cables



ISO 9001 2008 The World's Source for High Voltage Test Equipment **MADE IN THE USA**



OEM Products

HV AC & DC Supplies

High Voltage AC and DC Tanks
3 kV – 300 kV up to 40 kVA



Bushing Output Steel Tanks < 5pc Partial Discharge



High Voltage
Transformers

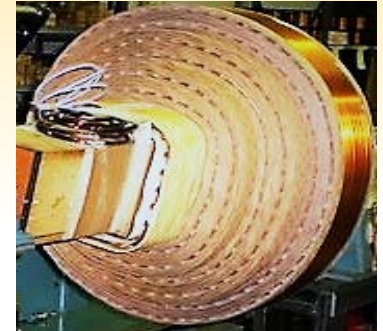

HV Isolation
Transformers



ISO 9001 2008 *The World's Source for High Voltage Test Equipment* **MADE IN THE USA**



Copake, NY in the Scenic Hudson Valley



100 miles North of New York City
50 miles SE of Albany, NY

30 miles East of the Hudson River
1 mile West of the CT & MA border



ISO 9001 2008

The World's Source for High Voltage Test Equipment **MADE IN THE USA**

High Voltage, Inc. • hvinc.com • p. 518.329.3275 • f. 518.329.3271 • 31 County Route 7A • Copake, NY 12516 USA

