



ALT-200(210)/50CC

SERIES

---

## Safety, Operation, and Procedure Instructions for the ALT Series of AC AERIAL LIFT Hipots

### Danger- Lethal Voltages:

#### Equipment to be used by trained personnel only

This Operator Manual contains instructions for the operation of a High Voltage power source. The operator of this equipment must use good judgement and follow all safety precautions noted in this guide to ensure the protection of himself and others in close proximity to the test area. **Failure to follow the instructions could result in injury or death. Proper grounding of the test set must be done prior to connecting this unit to a power source.**

---

# Operator Manual

---



© HIGH VOLTAGE, INC.  
31 Route 7A  
Copake, N.Y. 12516  
Phone 518/329-3275 • Fax 518/329-3271  
<http://www.hvinc.com>  
e-mail: [factory@hvinc.com](mailto:factory@hvinc.com)

# Table of Contents

About the Operator Manual	1
SECTION 1	
General Information	2
Features and Specifications	2,3
Controls and Indicators	4,5
List of included components	6
SECTION 2	
Setting up the Equipment	7
Operating the Equipment	8,9
Typical Hookups	10-15
Using GUARD/GROUND	16,17
Blank Page for Notes	18
SECTION 3	
Performing Special Operations	19
Meter Re-calibration	19,20
Miscellaneous	20
Packing the Cables	20
Return Material	21
Warranty	22,23
ATTACHMENTS	3 PAGES, PARTS LIST 2 PAGES, SCHEMATICS

## About the Operator Manual

### Important

*This Operator Manual describes the features and safe operation of a High Voltage Test Set. The instructions are intended to be clear and simple, but the operator must be trained and qualified according to established procedures for the use of this type of equipment.*

This Operator Manual is organized to provide information on the **ALT Series** in steps that familiarize the new operator with the operation of this test set.

Section 1: Specifications and Controls.

Section 2: Setup and Operation.

Section 3: Performing Special Operations.

The Functions, Features, and Specifications of the ALT Series of AC Hipots are also discussed in the ALT Brochure available from High Voltage, Inc.

## General Information

This section familiarizes the operator with the features and specifications of the **ALT Series of AERIAL LIFT AC Test Sets** manufactured by **HIGH VOLTAGE, INC.**

## Features and Specifications

The ALT Series of AC hipot test sets provide continuously adjustable output voltages for the testing of high voltage aerial lift booms.

Standard features of the ALT Series of AC Hipots

- 3.5 KVA input power, primary compensation for capacitive load
- Full 7.0 KVA , 50kV tap for Bucket Liner Testing
- Continuously adjustable output voltage
- Fixed overload, factory set to 120% of variable transformer rated output current
- "Zero Start" and External Interlock provision
- Secondary connected dual-range voltmeter
- Transit protected meters prevent meter damage between test sites
- Four range output current metering 0-250 $\mu$ A low range, 0-1.0mA with x1, x10, x100 multiplier for higher readings
- Guard/Ground return selector for isolating ground currents
- Secondary Capacitive Cancel circuit

## ALT MODEL SPECIFICATIONS

	<b>ALT-210/50FCC</b> Part No. ALT-1081S
Input	230 V, 50/60 Hz, 15 amps, single phase
Output	0-210kVac (15mA Max)/ 0-50kVac(60mA Max), 3KVA resistive load up to 7KVA capacitive load ; 417pF,210kV, (33mA Max) or 7.43nF, 50kV, (140mA Max), 60Hz
Output Termination	Top Toroid - 200kV 1 ½" Side Ball - 50kV
Duty	7KVA:1 hour ON, 2 hour OFF(30% DUTY) 4KVA: continuous (Capacitive Load)
Distortion	<5%
Meter Accuracy	2% F.S Accuracy
Kilovoltmeter	3.5 inch Scaled 0-20/50,0-80/210 kVac (RMS)
Current Meter	3.5 inch 0-250 $\mu$ A / 0-1.0 mA ac with multipliers
Case Size	21"w x 11"d x 15"high
HV TANK	15.5"w x 15.5"d x 37"high
Weight	CONTROL-59 lbs.(27kg) HV TANK- 240lbs.(109kg)

**Table 1** ALT –210/50FCC Specifications.

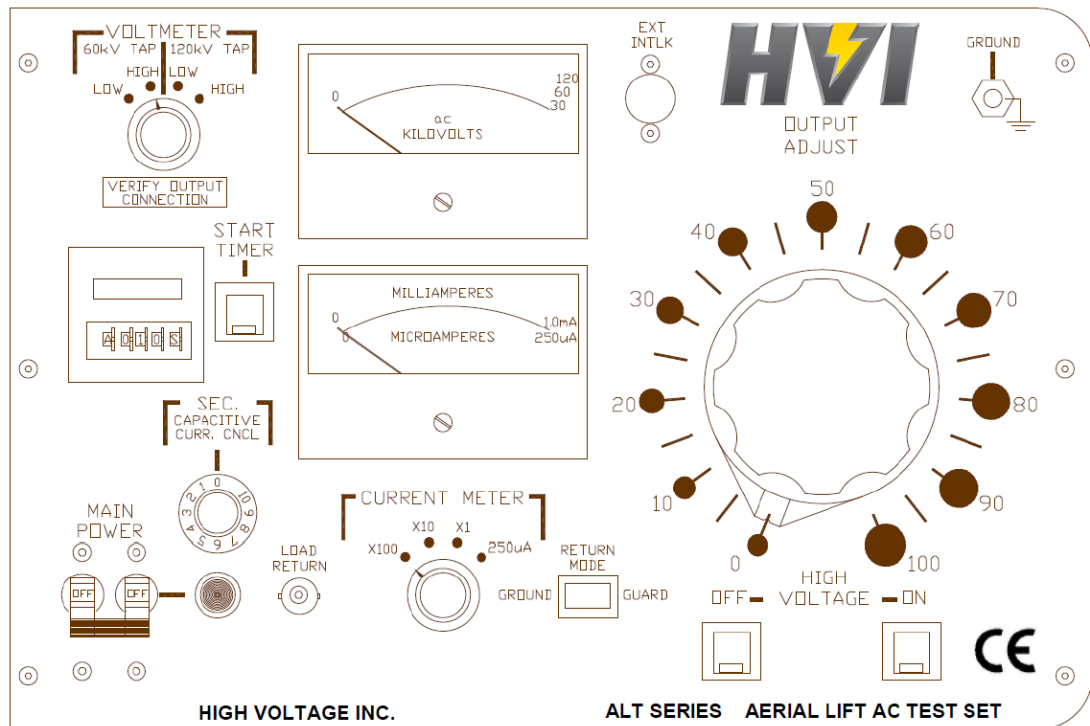

Figure 1 ALT Series front panel controls.

## MAIN POWER

The **MAIN POWER** circuit breaker provides protection and power to the control and power circuits. The red neon lamp will light when the power is on and voltage is available through input line cord.

## EXT. INTLK (EXTERNAL INTERLOCK)

The **Ext. Intlk.** connector is provided to allow for a normally open safety interlock switch to control the energizing of the high voltage output.

## HIGH VOLTAGE ON/OFF

The **HIGH VOLTAGE ON (OFF)** pushbuttons activate (de-activate) the high voltage power circuits. The LED indicators provide long life positive indication of the circuit status. The **RED (ON)** LED lights when high voltage is energized, the **GREEN (OFF)** LED lights when the high voltage is de-energized.

## OUTPUT CONTROL

The **OUTPUT** control variable transformer adjusts the output voltage. The 0-10 markings on the knob indicate the low to high setting. The control must be at ZERO (0) to energize the high voltage circuits. The output control must always be returned to zero at the completion of testing, prior to de-energizing the output

## VOLTMETER AND RANGE SWITCH

The **KILOVOLT METER** and associated range switch allows for more accurate output voltage readings. 1-% precision resistors minimize the need for re-calibration due to aging shift. The **OUTPUT**

**METERING** switch toggles the voltmeter drive between the full output metering string and the separate tap metering string. See **Voltmeter Re-calibration** in Section 3 for details on calibration.

## **CURRENT METER AND RANGE SWITCH**

The **CURRENT METER** and associated range switch secondary current monitoring. The 0-250 ac MICROAMPERES and the 0-1.0 ac MILLIAMPERES with it's associated multipliers provide sensitive readings when needed.

## **RETURN MODE (GUARD/GROUND)**

The **RETURN MODE** rocker switch is used to choose the current measuring mode of the test set. The option of guarded or grounded return measurements has application under various testing conditions. A Grounded return will measure the load currents in the test sample **plus any stray losses in the air, the unit, and test fixtures used.** NOTE: The use of the guarded mode is restricted to the ability to isolate the load or test sample low side from ground. The guarded return mode does enable more accurate load current measurement as the stray currents in the surrounding items are not measured as load current. In the guarded return mode, the currents to ground are diverted around the metering circuit. Further discussion of the application of the **GUARD/GROUND** circuit is found in **SECTION 2: OPERATING THE EQUIPMENT**, Using the Guarded Return.

## **TIMER AND START TIMER PUSHBUTTON**

The **Timer** is provided for tests when dwell time is important. The timer can be set from .1 second increments up to 10 hour increments. After the test has started, the timer can be started by depressing the **START TIMER** pushbutton. The preset time will count down to zero. Upon reaching zero, the timer will sound an alarm indicating the completion of the timing cycle. The timer will not shut down High Voltage. To Reset the timer alarm, with high voltage **OFF**, depress the **START TIMER** pushbutton.

### To set the timer.

- 1) Press 'Mode'. When 'Timing Range' appears. Press '1' pushbutton. When desired range appears move to next step.
- 2) Press 'Mode'. When 'UP/Down Count' appears, press '1' to choose 'UP' or 'DOWN'.
- 3) Press 'Mode'. When 'Output Mode' appears, press '1' until Mode 'A' appears.

This setup should be retained in the timers memory. To change the time in the future see step 1.

## **OPTIONAL CONTROL – NOT ALL UNITS**

## **SECONDARY CAPACITIVE CURRENT CANCEL**

The **SECONDARY CURRENT** compensation potentiometer is used to cancel capacitive load currents leaving the resistive component of the signal. To do this, the line signal is sampled and a phase shifted signal is inverted and summed with the load current signal into an OP AMP input. The resulting output, when adjusted to minimum, represents the resistive current in the load. When in the OFF position the capacitive cancel has no effect on the load signal.



### List of included components

- Two black test lead with black boot for ground connections
- Ext. Intlk. jumper plug
- 25 ft. shielded return lead
- 20 ft. Red Test Lead for high voltage connections

## SETTING UP THE EQUIPMENT

The setup of this equipment has been minimized by careful consideration of the operator during design. The **ALT Series'** solid construction and convenient storage area in the control cabinet minimizes damaged or misplaced components while allowing for portability.

1. **Position the high voltage section in the testing area.**
2. **Select a location** for the control unit that will allow easy viewing of the meters at a safe distance from the test object and high voltage section.
3. **Be sure that all the controls are off**, in their de-energized or fully counterclockwise position.
4. **Secure a ground test lead to the panel.** The **Ground** stud on the front panel should be used for that purpose. A black test lead with black boot has been provided for the ground connection. A second ground lead is provided for the grounding of the high voltage section.
5. **Insert the EXT INTLK plug into the socket on the panel.** The plug may also be wired to a normally open contact of a safety switch for added protection.
6. **Connect the interconnect cable between the control and high voltage section.**
7. **Choose which output to connect to the load.** Termination of the 200 kVac output toroid on the **ALT-210/50** high voltage section to the load can be accomplished by using test lead or tubing (metallic) between the toroid and test object. Approximately one inch of diameter per 50 kV of test voltage will reduce corona levels. Locating the needed test lead or pipe now will preclude delays when the instructions for connecting to the load are given.

**Connection to the 50 kVac tap on the side of the cylinder can be done in a similar fashion.**

## Operating the Equipment

This section provides step-by-step instruction on various test methods. Refer to FIGURES 2-7 for various setups. Many facilities have their own in-house test procedures, and this manual is not to supercede these. The purpose of this section is to explain the capabilities of this test set.

### *Aerial Boom Truck Testing*

1. Ensure that all the steps listed in **Setting up the Equipment** have been accomplished. Take special note to ground the control panel to a solid earth ground using the supplied black test lead.
2. Select the desired **VOLTMETER RANGE** for the test voltage level expected. Verify which output tap is being used and choose corresponding voltmeter range.
3. Prior to connecting the output cable to the test sample, be sure that the test sample is de-energized. High Voltage has supplied a red test lead for these connections. It must be suspended in air.
4. Connect the output lead to the test sample. *Be sure that there is enough clearance to grounded objects for the expected test voltage. The minimum clearance in air is 10 kV ac/inch.*
5. *Connect the low side of the test object to the LOAD RETURN cable.*
6. Connect the input power cord to a grounded source (See the specification table for unit input requirements). If the distance to a power source is greater than the cord provided, a standard **grounded** extension cord rated for the full input current may be used.
7. Depress the **MAIN POWER** switch to energize the control circuits.

\* \* \* CAUTION \* \* \*

POTENTIALLY LETHAL VOLTAGES  
MAY BE PRESENT

---

8. With the **OUTPUT** control at zero (zero start interlock engaged), depress the **HV ON** pushbutton. The **HV ON** light will glow.

9. Increase the output by rotating the **OUTPUT** control slowly clockwise until the desired output voltage is reached. When operating the unit above 4KVA, be sure to observe the duty cycles noted on the SPECIFICATIONS page.
10. Rotate the current meter range to an appropriate range for monitoring the leakage current in the load. The load current scales are **0-250 ac MICROAMPERES** and **0-1.0 ac MILLIAMPERES**. The x1, x10, x100 multipliers are for the 0-1.0 mA scale only. Refer to **FIGURES 2-7** for **RETURN MODE** position (GUARD or GROUND) if the current meter does not deflect.
11. The **SECONDARY CAPACITIVE CURRENT CANCEL** control can be adjusted for minimum reading on the current meter. The resulting minimized reading represents the resistive leakage current flowing in the load. This reading will not contain any current flow due to capacitive losses caused by the test setup. The use of this feature is not specified in any ANSI test, but for diagnostic purposes the number can be recorded and referenced for trending information. In sensitive ranges, the potentiometer must be moved very carefully as over compensation will add to the readings.
12. Set and start the timer as needed for timing the test duration. Maintain the output voltage for the test time specified in your standard procedures.
13. After the test is complete, rotate the **OUTPUT** control to zero, depress the **HV OFF** pushbutton. Turn off **MAIN POWER** switch. When the timer has counted to zero, an audible alarm will sound. Reset the timer after turning off the high voltage by depressing the **START TIMER** pushbutton.
14. If the test sample fails during the test, the internal overload relay will de-energize the high voltage. **This relay is in the primary circuit and is sensitive to primary current overloads.** The overload is set to 120% of the rated current of the variable transformer.
15. Prior to removing the output connection from the load, observe that the output voltmeter is at zero.

Use a grounding device prior to touching any high voltage connections.

### Caution

When using the 50kVac tap, the 210 kV toroid is energized. Route wires to preclude arc-over and possible damage to the test object.

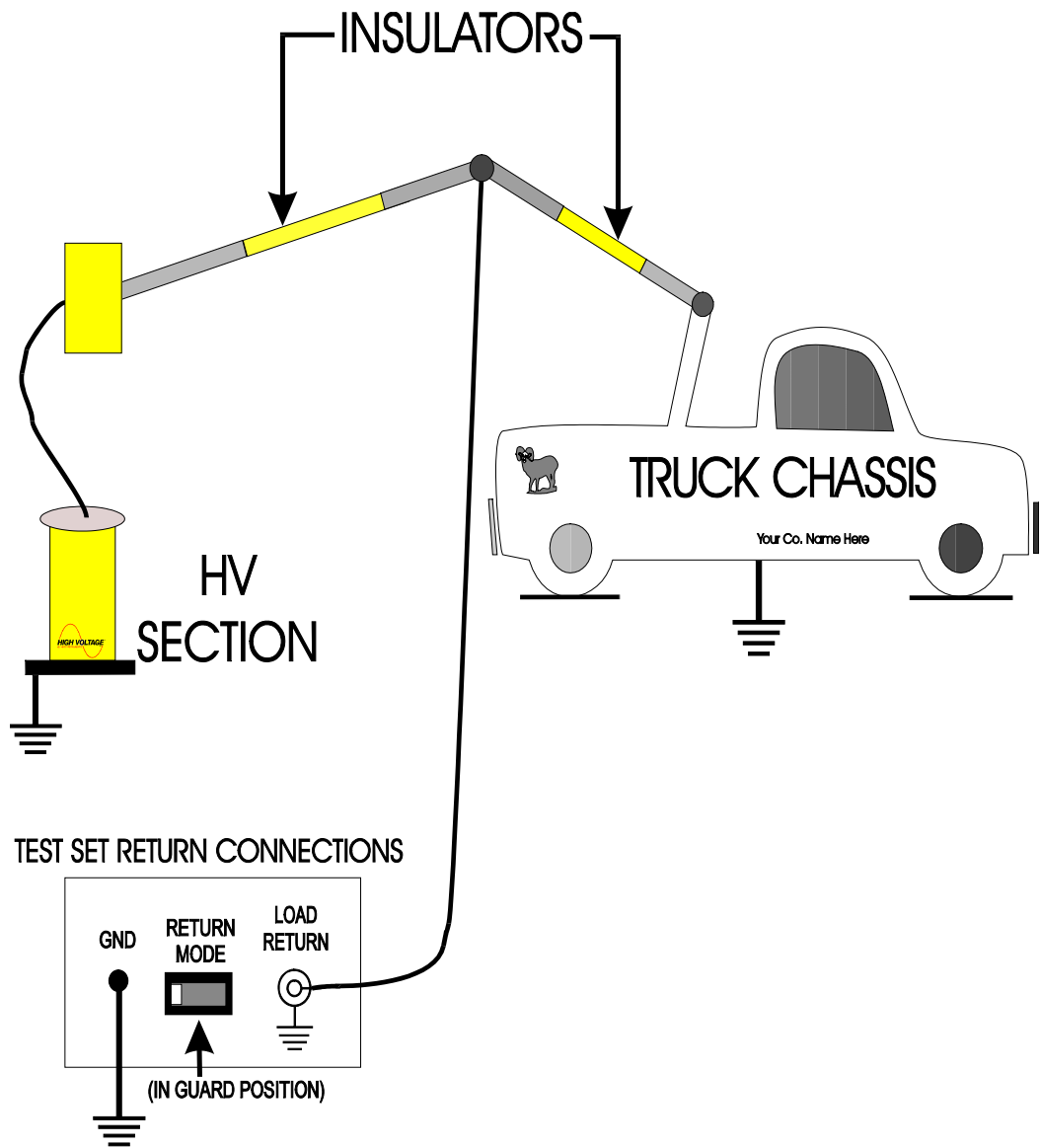

ANSI TEST ON UPPER INSULATED  
 ARM OF A DOUBLE INSULATED  
 AERIAL BOOM TRUCK

FIGURE 2

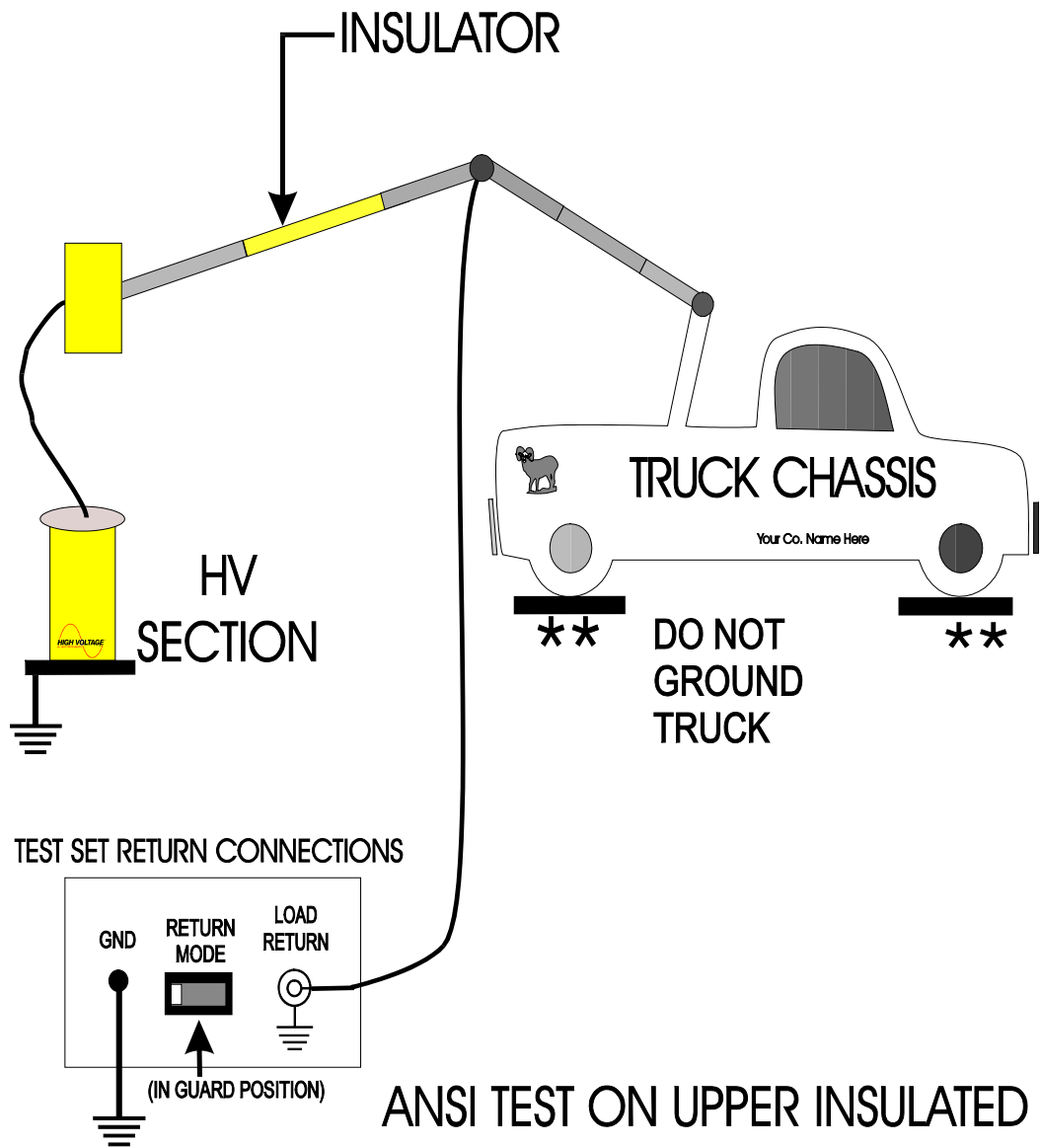

**ANSI TEST ON UPPER INSULATED  
ARM OF A SINGLE INSULATED  
AERIAL BOOM TRUCK**

**\*\* INSULATOR PADS MAY BE  
NEEDED. DAMAGE MAY RESULT  
TO TIRES IF PADS ARE NOT USED**

**FIGURE 3**

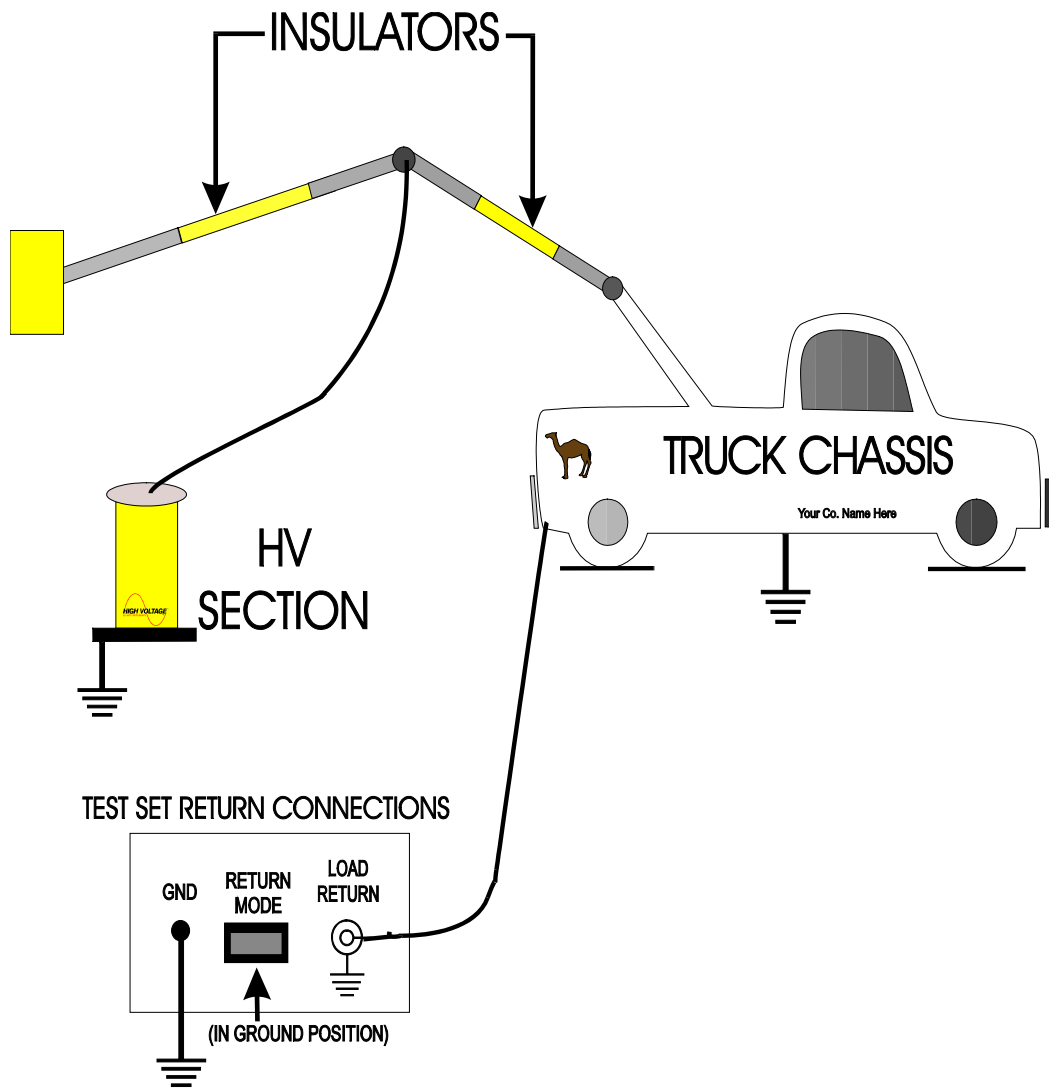

FLASH OVER TEST ON LOWER INSULATED ARM OF A DOUBLE INSULATED AERIAL BOOM TRUCK

FIGURE 4

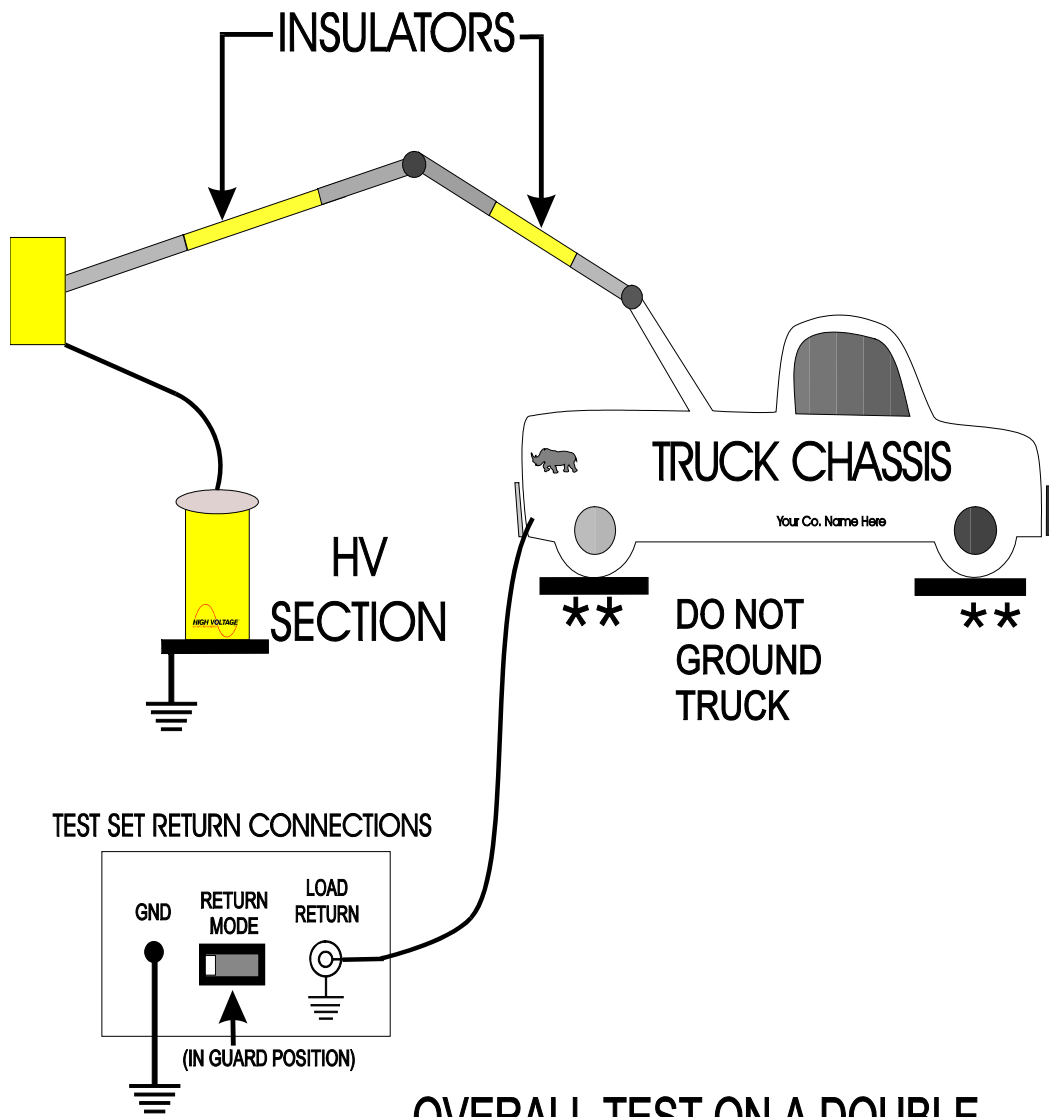

## OVERALL TEST ON A DOUBLE INSULATED AERIAL BOOM TRUCK

\*\* INSULATOR PADS MAY BE NEEDED. DAMAGE MAY RESULT TO TIRES IF PADS ARE NOT USED

FIGURE 5

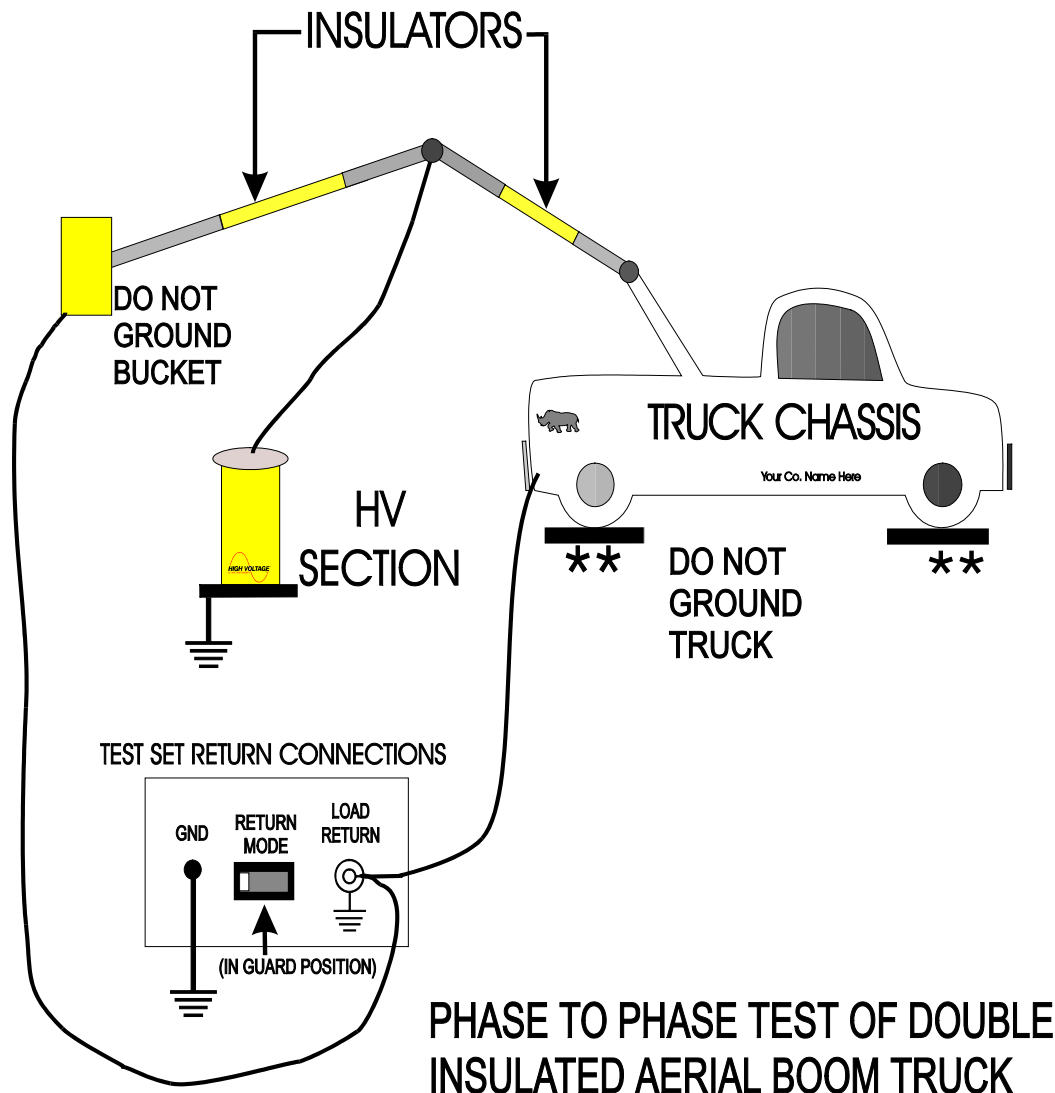

**FIGURE 6**

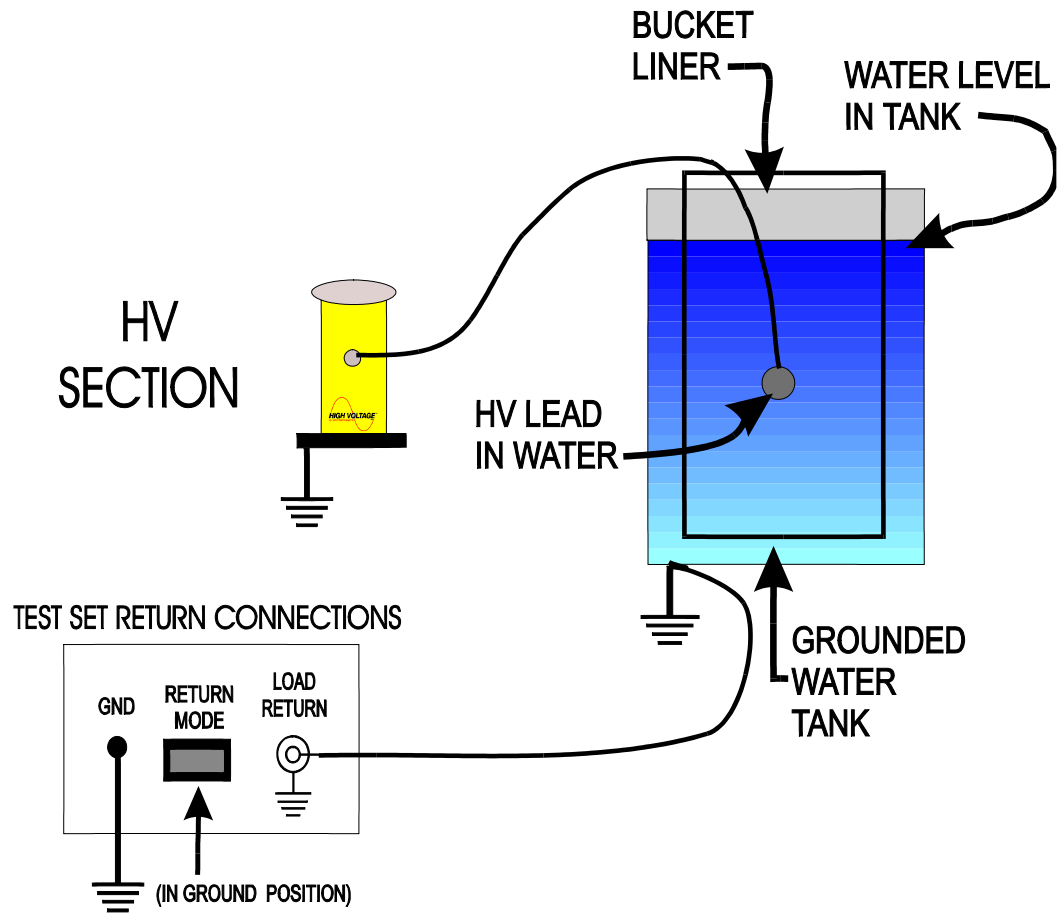

## FLASHOVER TEST ON BUCKET LINER IN WATER

FIGURE 7

## Using the Guarded Return

The use of the GUARD/GROUND return feature of this test set provides for very accurate leakage current measurements if certain conditions exist allowing for the GUARD circuit to be employed. The following explanation will detail different test samples and methods that lend themselves to the use of this circuit. The same setup precautions such as proper grounding still apply to the test but the grounds will be manipulated to accomplish the test requirements.

1. **Grounded Return-** With the output return in the grounded mode, the current meter reads all current to ground, internal and external to the power supply. This current might include corona, surface tracking, and any shunt resistance. The typical diagram for grounded return operation is shown in **Figure 2** below.

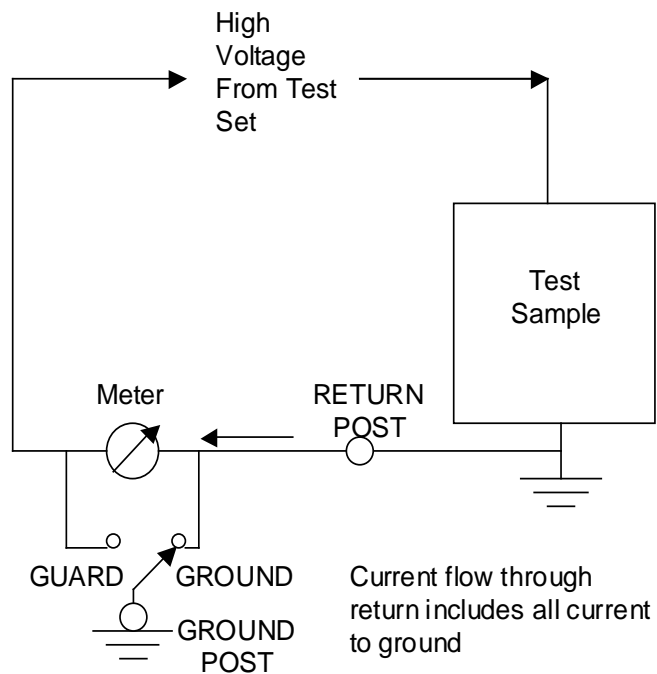

Figure 2, Grounded Return Diagram

2. **Guarded Return-** With the output return in the guarded mode, the current meter will only read currents through the test sample. The test sample must be isolated from ground on the low side as shown in Figure 3 below.

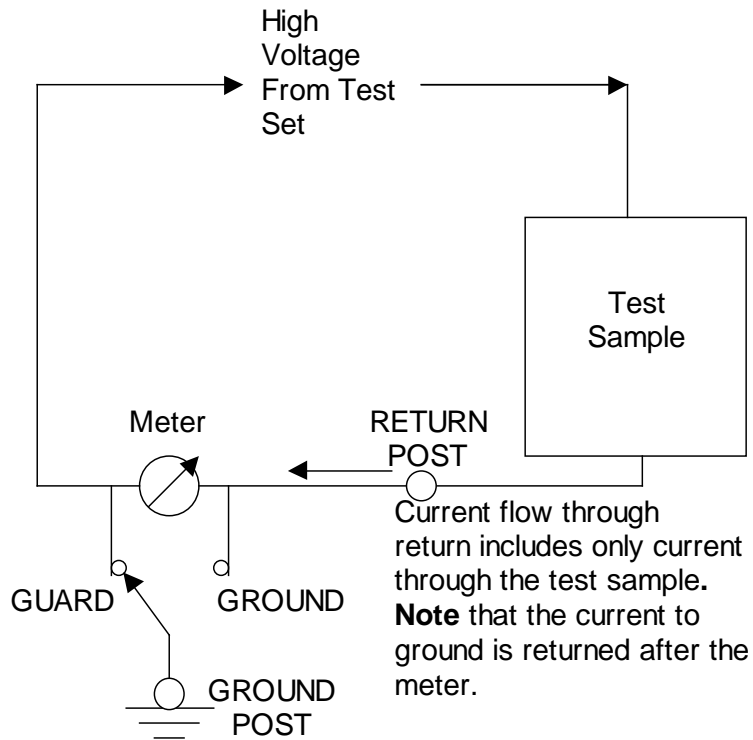

Figure 3, Guarded Return Diagram

THIS PAGE LEFT BLANK FOR APPLICATION NOTES

## PERFORMING SPECIAL OPERATIONS

The following section contains information on the care and upkeep of your new ALT SERIES AERIAL LIFT AC Test Set. There are some notes on troubleshooting and service, which will save much time and money over the life of the unit.

### Meter Re-calibration

The ALT SERIES of hipots use precision metal film resistors for measurement and calibration of the voltmeter. The use of these resistors in both the high voltage tank and the metering circuits has minimized circuit drift due to aging and temperature. But, a potentiometer (R4) on the voltmeter PCB can be used to correct for movement changes from the aging of the meter.

**The certification of meters on a yearly basis is recommended to ensure accurate test results.**

### *Voltmeter Re-calibration*

1. Locate the unit in a position that will allow easy reading of the meters.
2. Remove the panel screws and support the panel vertically to gain access to the calibration pot on the back of the voltmeter.
3. Zero the meter movement using the zero adjustment below the scale window.
4. Perform the steps in **Setting up the Equipment** at the start of **SECTION 2**. Be sure to ground the front panel AND THE HIGH VOLTAGE TANK to a solid earth ground using the supplied black ground test lead prior to connecting the unit to input power.
5. Set the **VOLTMETER RANGE** to **LOW** position.
6. Connect the output toroid to a calibrated reference meter with ability to read to the full output voltage of the unit. Be sure to ground the low side of the meter.
7. Raise the output to one half scale on the unit meter. Adjust R4 as required.

8. Check calibration at full scale and on the high range at both half and full scale. If the customer facility calibration certification requires more points of reference, follow those procedures instead of these.
9. Calibration must then be verified with the panel in the horizontal operating position to check for any meter balance affect on the calibration.
10. Repeat the procedure for the 50kV side tap calibration, with the reference meter connected to the tap. **KEEP IN MIND THAT THE TOP TOROID IS ENERGIZED AT THE SAME TIME.**

## Miscellaneous

### *Oil Insulated High Voltage Tanks*

The oil-filled tanks in all the ALT SERIES of hipots are field serviceable. The only requirement is that the tank must be oil filled under vacuum at re-assembly if left out of the oil for longer than 3 hours. The parts to service the tank are available from HIGH VOLTAGE, INC. at the address noted on the inside front cover of this manual.

The oil level in the tank should be .75 inches from the top header when the oil temperature is 20°C.

### *Packing the Cables*

The interconnect cable and input line cord will easily fit into the cable storage area next to the control panel. Care should be used to avoid damaging the interconnect cable jacket when coiling into the compartment. The input line cord and ground lead will coil neatly inside the interconnect cable coil.

## **RETURNED MATERIAL**

If for any reason it becomes necessary to return any equipment or materials to High Voltage, Inc., the Service Department of High Voltage, Inc. must be notified, and authorization received, prior to the shipment of the equipment. When notified, the following information must be provided:

MODEL:

SERIAL NO:

PART NO:

REASON FOR RETURN:

SUSPECTED DEFECT:

CAUSE OF DEFECT:

With the above information provided, High Voltage, Inc. will determine if the return of the equipment is appropriate. If deemed appropriate, a Return Authorization Number will be issued. At that time, the Purchaser will be instructed how to mark and return the equipment.

The above procedure must be adhered to in order to ensure prompt service. No equipment should be returned without the prior knowledge and authorization of High Voltage, Inc.

## **REPLACEMENT PARTS ORDERING**

To order replacement parts, first refer to the Parts List for the product in question. Every part is issued a part number. It will be necessary for this part number and the product model and serial number to be provided. When calling High Voltage, Inc. request the Service Department.

THESE TERMS AND CONDITIONS OF SALE AND LIMITED WARRANTY OF HIGH VOLTAGE, INC. ("High Voltage") SHALL BE GOVERNED BY AND CONSTRUED ACCORDING TO THE INTERNAL LAWS OF THE STATE OF NEW YORK, USA, WITHOUT GIVING EFFECT TO ITS CONFLICT OF LAWS PROVISIONS. THE RIGHTS AND OBLIGATIONS OF ALL PARTIES AND ALL PERSONS OR ENTITIES CLAIMING HEREUNDER SHALL NOT BE GOVERNED BY THE PROVISIONS OF THE 1980 U.N. CONVENTION ON CONTRACTS FOR THE INTERNATIONAL SALE OF GOODS.

1. **ACCEPTANCE.** All orders become effective only when accepted by High Voltage's written order acknowledgment at Copake, New York, USA. Unless modified in writing by an authorized representative of High Voltage, or modified in High Voltage's Quotation or order Acknowledgment, these Terms and Conditions and Limited Warranty shall solely control Purchaser's order. High Voltage expressly rejects any additional or different provisions, terms or conditions proposed by Purchaser at any time.

2. **SCHEDULING.** High Voltage's shipping date specified in High Voltage's quotation or purchase order acknowledgment is approximate and High Voltage shall use reasonable commercial efforts to effect timely shipment. Furthermore, High Voltage shall not be liable for any delay in the performance of orders or contracts or in the delivery or shipment of goods or for any damages suffered by Purchaser by reason of such delay when such delay is, directly or indirectly, caused by, or in any manner arising from Purchaser's fault, fires, floods, accidents, riots, acts of God, war, governmental interference or, embargoes, strikes, labor difficulties, shortage of labor, fuel, power, materials or supplies, transportation delays, or any other cause or causes (whether or not similar in nature to any of these hereinbefore specified) beyond the control of High Voltage.

3. **CANCELLATIONS.** Prior to shipment, Purchaser may request cancellation or delayed delivery of an order or part thereof, but such shall be conditioned upon written consent of High Voltage and upon payment to High Voltage of cancellation or delayed delivery charges to be determined by High Voltage.

4. **SALE AND DELIVERY.** Unless otherwise agreed in writing, sale and delivery of the goods hereunder shall be made EXW or FCA (Incoterms® 2020) at High Voltage's option, High Voltage's dock at Copake, New York, USA, at which time all risk of loss or damage shall pass to Purchaser. All shipments and packaging shall be made in the manner determined by High Voltage, unless otherwise requested by Purchaser, in which case any resultant additional charges and expenses shall be paid by Purchaser.

5. **TAXES.** Any and all sales, use, excise and similar taxes, and duty and all other charges levied or imposed by governmental authority, foreign and domestic, upon any goods sold or contracted to be sold shall be paid by Purchaser and added to the purchase price unless appropriate tax exemption certificates are supplied to High Voltage in form satisfactory to High Voltage.

6. **PAYMENTS.**

a. All payments shall be in US Dollars without discount unless otherwise specified in High Voltage's order acknowledgment. Credit card payments are accepted only if specified in High Voltage's order acknowledgment.

b. Terms of payment are net thirty (30) days from date of invoice, unless otherwise agreed by High Voltage in its order acknowledgment. Delinquent payments are subject to a service charge on the unpaid balance from invoice date equal to the lower of 1-1/2% per month or the maximum rate permitted by law until all amounts are paid in full. If the financial responsibility of Purchaser becomes unsatisfactory to High Voltage for any reason, or if Purchaser has been in default to High Voltage under any order, High Voltage may require full payment in cash before shipment of goods.

c. If Purchaser so requests and makes arrangements prior to shipment

which meet High Voltage's full satisfaction, High Voltage in its discretion may accept irrevocable letters of credit in its favor issued by a United States bank which is satisfactory to High Voltage.

7. **INFRINGEMENT, ETC.** On goods manufactured to Purchaser's specifications, Purchaser shall and does indemnify and hold High Voltage harmless against any claims, damages, liabilities, costs and expenses (including attorneys' fees) arising out of or resulting from actual or alleged infringement of patent, copyright, trademark or other proprietary rights, or claim of unfair trade or unfair competition arising from or occasioned by the use, possession, sale or delivery of any such goods sold by High Voltage.

8. **REPRODUCTION RIGHTS.** Drawings, specifications, reports, photographs and other data relating to all orders and all proprietary rights and interests therein and the subject matter thereof shall be and remain the property of High Voltage. Purchaser agrees that it shall not use High Voltage's drawings, specifications or other materials covered by this order, or any similar article from any other source, or reproduce the same or otherwise appropriate them, without the prior written authorization of High Voltage.

9. **LIMITED WARRANTY.**

a. High Voltage warrants to the original Purchaser of any new goods that the goods are free from defects in material and workmanship under normal use and service for a period of one (1) year from the date of shipment by High Voltage. The obligation of High Voltage under this Limited Warranty is limited, in High Voltage's exclusive option, to repair, replace with new or reconditioned parts or issue credit for goods, parts or materials which prove to be defective. Costs incurred by Purchaser for labor or other expenses to repair or replace such goods, parts and/or materials shall be the sole responsibility of Purchaser. High Voltage shall not be responsible for any damage or lack of performance resulting from: (i) defects due to accident, negligence, alteration, modification, faulty installation, abuse or misuse, whether by Purchaser, Purchaser's agents or employees, or by others than High Voltage (ii) attempted or actual dismantling, disassembly, service or repair by any person, firm or corporation not specifically authorized in advance in writing by High Voltage, or (iii) defects caused by or due to handling by carrier, or incurred during shipment, transshipment or other move.

b. High Voltage expressly disclaims any warranty whatsoever of (i) consumables, and of (ii) parts, components, software (including but not limited to object code and source code and software user instructions), accessories, and materials not prepared, compiled or manufactured by High Voltage, and Purchaser must deal directly with such other supplier. High Voltage may elect to assist Purchaser in settling such claim against such other supplier, but any such assistance shall not prejudice High Voltage's position as to its own liability.

c. Compliance with the following Limited Warranty Claim Procedure is a condition precedent to the obligation of High Voltage under this Limited Warranty:

i. Purchaser must notify High Voltage in writing as soon as is reasonably possible, but within the applicable warranty period, of any alleged defect in material, workmanship, or operation of any goods covered under this Limited Warranty. Such notice must describe in detail the defect, any and all defective parts, and the alleged cause of the defect. No goods may be returned to High Voltage without High Voltage's prior written permission, which permission may be withheld by High Voltage in its sole discretion.

ii. At the exclusive option of High Voltage, Purchaser may be directed in writing to dismantle the goods at the Purchaser's cost and expense and ship the goods prepaid to High Voltage (refer to "Returns" Section 10 for provisions regarding the return of any goods to High Voltage). If High Voltage elects to inspect the goods at Purchaser's site, and to repair, replace,

*[Section 9.c.ii. continued on reverse]*

or ship the defective goods to High Voltage's factory, Purchaser, at its own cost and expense, shall provide the facilities for such work as needed to inspect and evaluate and possibly repair/replace the goods. If inspection discloses that the defect is not one for which High Voltage is liable, then Purchaser shall promptly reimburse High Voltage for all expenses incurred.

iii. Upon receipt of the defective goods, or following access to the same, High Voltage shall inspect and evaluate the goods and determine the validity of Purchaser's claim.

iv. The validity of any warranty claim, Purchaser's compliance with the Limited Warranty and Limited Warranty Claim Procedure, and the obligation to replace, repair, or issue credit for any goods are solely and exclusively to be determined by High Voltage and any determination shall be final and binding.

d. THIS WARRANTY IS EXPRESSLY IN LIEU OF ALL OTHER WARRANTIES, STATUTORY OR EXPRESSED OR IMPLIED ON THE PART OF HIGH VOLTAGE, INCLUDING THE WARRANTIES OF MERCHANTABILITY, FITNESS FOR A PARTICULAR PURPOSE, AND NON-INFRINGEMENT; FURTHERMORE, HIGH VOLTAGE MAKES NO WARRANTY REGARDING NON-INTERRUPTION OF USE OR SOFTWARE FREE OF BUGS. HIGH VOLTAGE NEITHER ASSUMES NOR AUTHORIZES ANY OTHER PERSON, FIRM, OR CORPORATION TO ASSUME ANY LIABILITY OR OBLIGATION IN CONNECTION WITH THIS SALE OR LIMITED WARRANTY ON HIGH VOLTAGE'S BEHALF AND PURCHASER ACKNOWLEDGES THAT NO REPRESENTATION EXCEPT THOSE MADE HEREIN HAS BEEN MADE TO PURCHASER.

10. **RETURNS.** No goods may be returned to High Voltage without High Voltage's prior written permission, which permission may be withheld by High Voltage in its sole discretion. Any request for return authorization must be in writing and include, as applicable, model number, serial number, part number, reason for return, alleged defect, and apparent cause of alleged defect. Except as specifically provided in Section 9 Limited Warranty, if High Voltage consents to return of goods: (a) all return shipments are to be via prepaid freight and with all other charges prepaid, (b) if goods are returned to High Voltage within sixty (60) days from the date of original shipment for reasons other than an error by High Voltage in filling the Purchaser's order, Purchaser shall only be entitled to receive a credit in an amount equal to the payment received by High Voltage for the goods minus (i) handling charges, and (ii) a restocking fee determined solely by High Voltage which shall not exceed twenty five percent (25%) of the invoiced amount, and (c) if goods are returned to High Voltage after sixty (60) days from the date of original shipment for reasons other than an error by High Voltage in filling the Purchaser's order, Purchaser shall only be entitled to receive a credit in the amount equal to the payment received by High Voltage for the goods minus (x) a handling fee, and (y) a restocking fee in excess of twenty five percent (25%) which shall be determined by High Voltage.

11. **SECURITY INTEREST.** In order to induce High Voltage to ship goods without full payment, Purchaser grants a security interest to High Voltage in any and all of Purchaser's right, title and interest in the goods, and Purchaser agrees to comply with any reasonable request of High Voltage to perfect such security interest. Purchaser hereby further authorizes High Voltage to perfect High Voltage's security interest in said goods and consents to filing one or more financing statements without the signature of Purchaser.

12. **ARBITRATION.** Any controversy arising out of or relating to this document, or any breach thereof, including, without limitation, any claim that this document is voidable or void, shall be submitted to final and binding arbitration before, and in accordance with, the Commercial Rules of the American Arbitration Association then in effect, and judgment upon the award may be entered in any court have jurisdiction thereof; provided, however, that this clause shall not be construed to limit any rights which

High Voltage may have to apply to any court of competent jurisdiction for equitable, injunctive or provisional relief. This arbitration provision shall be deemed self-executing, and in the event that either party fails to appear at any properly noticed arbitration proceeding, an award may be entered against such party notwithstanding said failure to appear. Such arbitration shall be conducted before a single arbitrator under the aegis of the American Arbitration Association in Columbia County, State of New York. The arbitrator shall have the authority to award expenses to the successful party.

13. **LIMITATION OF LIABILITY.** TO THE MAXIMUM EXTENT PERMITTED UNDER APPLICABLE LAW, AND NOTWITHSTANDING ANYTHING ELSE IN THIS DOCUMENT OR OTHERWISE, INCLUDING THAT HIGH VOLTAGE WAS WARNED THAT DAMAGES WOULD OCCUR OR WERE LIKELY TO OCCUR, HIGH VOLTAGE SHALL NOT BE LIABLE WITH RESPECT TO ANY SUBJECT MATTER OF THIS DOCUMENT UNDER ANY CONTRACT, NEGLIGENCE, STRICT LIABILITY OR OTHER LEGAL OR EQUITABLE THEORY FOR (i) ANY AMOUNTS IN EXCESS IN THE AMOUNT PAID TO HIGH VOLTAGE FOR THE PARTICULAR GOODS OR PART THEREOF WHICH GAVE RISE TO THE APPLICABLE CAUSE OF ACTION OR CLAIM, OR (ii) ANY INDIRECT, INCIDENTAL OR CONSEQUENTIAL DAMAGES, LOST PROFITS OR LOST OR CORRUPTED DATA, OR (iii) COST OF PROCUREMENT OF SUBSTITUTE GOODS, SOFTWARE, TECHNOLOGY OR SERVICES. HIGH VOLTAGE SHALL HAVE NO LIABILITY FOR ANY FAILURE OR DELAY DUE TO MATTERS BEYOND ITS REASONABLE CONTROL.

14. **SEVERABILITY.** These Terms and Conditions and Limited Warranty are the entire understanding between Purchaser and High Voltage with respect to the subject matter hereof and supersede all prior agreements, dealings and negotiations. No modification, alteration or amendment shall be effective unless made in writing and signed by a duly authorized representative of High Voltage. No waiver of any breach hereof shall be held to be a waiver of any other or subsequent breach. Nothing contained in this document shall be construed as requiring the commission of any act contrary to law. Whenever there is any conflict between any provision of this document and any present or future statute, ordinance or regulation contrary to which the parties have no legal right to contract, the latter shall prevail, but in such event the provision of this document thus affected shall be curtailed and limited only to the extent necessary to bring it within the requirements of the law. In the event that any part, article, section, paragraph, sentence or clause of this document shall be held to be indefinite, invalid or otherwise unenforceable, the entire document shall not fail on account thereof, and the balance of the document shall continue in full force and effect. If any arbitration tribunal or court of competent jurisdiction deems any provision hereof (other than for the payment of money) unreasonable, said arbitration tribunal or court may declare a reasonable modification thereof, and this document shall be valid and enforceable, and the parties hereto agree to be bound by and perform the same as thus modified.

15. **BASIS OF BARGAIN.** Each party recognizes and agrees that the warranty disclaimers and liability and remedy limitations in this document are material, bargained for bases of their agreement and that they have been taken into account and reflected in determining the respective obligations of the parties.

[End]



# THE WORLD'S SOURCE FOR HIGH VOLTAGE TEST EQUIPMENT

ADVANCED TEST EQUIPMENT FOR HIGH VOLTAGE PROOF AND PREVENTIVE MAINTENANCE TESTING OF ELECTRICAL APPARATUS

## DC Hipot/Megohmmeter Test Sets

**Two Testers in One**

80 kVdc 10 mA

100 kVdc 10 mA

**\*\*Top DC**

Bucket Truck Tester

## AC Hipots - Field Portable

30 kVac @ 1 kVA

50 kVac @ 3 kVA Cable Output **\*\***

Only 1 piece

**Built for Field Use**

Portable

Affordable

Rugged & Reliable

Easily Serviceable

100 kVac @ 3 kVA

## Aerial Lift Test Sets - AC

0 - 60/120 kVac

7 kVA capacitive\*

4 kVA resistive

Long duty cycle

Bucket Truck Tester

**\*\* Top AC**

Great for other AC applications

300 kVac 7 kVA

## Oil Dielectric Testing

Standard & Micro Controlled

60 kVac & 100 kVac models

60 kVac

.5/2/3 kV/sec

Digital Display

60 kVac

Fully Programmable Panel Printer

## Very Low Frequency AC Technology

**VLF**

Cables & Motors/Generators

0.1 - 0.01 Hz up to 200 kVac

**VLF Withstand**

**VLF TD & VLF PD**

200 kVac peak - sine wave 0.1 - 0.02 Hz to 3.75 uF

90 kVac peak - sine wave 0.1 - 0.02 Hz to 2.75 uF

30 kVac 0.4 uF

Many more models avail.

**\*\* New Solid State Design**

62 kVac peak - sine wave 0.1 - 0.01 Hz to 5.5 uF

**Wind Farm Model**

34 kV peak - sine wave 0.1 - 0.01 Hz to 7 uF

VLF - TD **\*\* Pair \***

## 50/60 Hz AC Dielectric Test Equipment: 5 kVA - 50 kVA

AC Testing of High Capacitance Loads - up to 300 kVac

100 kVac 10 kVA PD <10 pc

5 kVac @ 1 A Motor Testing

10 kVac @ 10 kVA Low PD < 10 pc

## Concentric Neutral Resistance Tester

**Ω-CHECK™**

## HV Dividers

150 kV AC/DC

300 kV AC/DC

## VLF Diagnostic Cable Testing

Tan Delta & Partial Discharge

TB-60 0 - 60 kVac

TD-34E 0-34 kV

TD/PC Meas. 40 - 200 kV

## Capacitor Discharge Systems - Thumpers

Three Full Joule Outputs - VLF/Thumper Combo

Models for URD & Network Systems

**\*\* VLF - Thumper**

0-9/18/36 kV 3200 400mA

TDR/Radar

**\* Van Package \***

## Parts List ALT-210/50FCC (230V, W/CAP CNCL)

### Schematic # ALT-1081S

<u>REF.</u>	<u>QTY</u>	<u>HVI#</u>	<u>DESCRIPTION</u>
AL	1	16-010	ALARM, SONALERT, 24-110 Vac/dc, SONALERT # SC110
C1	1	03-160	CAPACITOR, AC, 2 $\mu$ F, 660 Vac
	1	03-810	BRACKET, CAPACITOR
CAB	1	32-033	CABINET, PORTABLE TRANSIT ENCLOSURE. CHARCOAL GRAY 19W x 10D x 14 H ID
CB1	1	06-118	CIRCUIT BREAKER, THERMAL-MAGNETIC, 250V, 15 AMP, 2 POLE, AIRPAX # UPGH66-1-72-153-01
D1	1	04-030	DIODE, 1N5408A
D2-4	3	04-025	DIODE, 1N4007
J2	1	07-440	CONNECTOR, BULKHEAD, 2 SOCKET, CINCH #S302AB
J3	1		CONNECTOR, BULKHEAD, CIRCULAR, PART OF HIGH VOLTAGE TANK
J4	1	07-206	CONNECTOR, BULKHEAD, BNC, AMPHENOL # UG1094A/U
	1	07-210	RING TERMINAL, GROUNDING LUG
K1	1	11-170	CONTACTOR, DPST, 40A, 120Vac COIL, WWG #4DD05
K2	1	11-152	RELAY, DPDT, 115 Vac COIL, MIDTEX # 25862T200
K3,4	2	11-150	CONTACTOR, 3PDT, 15A, 120 Vac COIL, MAGNECRAFT # W389ACX-14
M1	1	13-405	METER, ANALOG, 100 $\mu$ A MOVEMENT, SCALED 0-20/50,0-80/200 (210) AC KILOVOLTS
M2	1	13-165	METER, ANALOG, 100 $\mu$ A MOVEMENT, SCALED 0-250 AC MICROAMPERES/0-1 AC MILLIAMPERES
MOV1,3	2	06-207	METAL OXIDE VARISTOR, # V130LA10A
MOV2	1	06-210	METAL OXIDE VARISTOR, # V250LA10A
P1	1	22-422	INPUT POWER CABLE, EUROPEAN COLORS, 16-3, 3m (9'10") L.
P2	1	07-442	CONNECTOR, CABLE, 2 CIRCUIT, CINCH# P302CCT
	1	23-234	COVER, BLACK VINYL, .625 ID, .5 DEEP
P3	1	07-014	CONNECTOR, CABLE, CIRCULAR, 7 CKT, AMPHENOL # 97-3108B-20-15S
	1	07-082	CONNECTOR, CLAMP, AN-3057-12
PCB-001-PFT12	1		PRINTED CIRCUIT BOARD, VOLT METER
PCB-007A	1		PRINTED CIRCUIT BOARD, AC OVERLOAD, REV A
PCB-001-CM	1		PRINTED CIRCUIT BOARD, CURRENT METER
PCB-008b	1		PRINTED CIRCUIT BOARD, CAPACITIVE CURRENT CANCEL
PL1	1	15-136	PILOT LIGHT, 250V NEON, RED, IDI # 1051QC1
R1	1	02-202	RESISTOR, POTENTIOMETER, 1K, 2W, CLAROSTAT # 53C1SW
R1S1	1	02-202	SWITCH, SPST, N.O., P/O S4, CLAROSTAT # 53-10
R2	1	01-500	RESISTOR, WIREWOUND, 10K, 25W, 5%
	2	01-900	BRACKETS, RESISTOR, 25W
S1	1	10-220	SWITCH, PB, MOM., 125 Vac, 15A, SPDT, YEL LED, MICROSWITCH # AML22CBJ2AA
S2	1	10-222	SWITCH, PB, MOM., 125 Vac, 15A, SPDT, GRN LED, MICROSWITCH # AML22CBS2AA
S3	1	10-218	SWITCH, PB, MOM., 125 Vac, 15A, SPDT, RED LED, MICROSWITCH # AML22CBC2AA
	3	10-252	SWITCH, PB COVER, BLACK, MICROSWITCH # AML52-C10K
S4	1	10-106	SWITCH, SNAP ACTION, SHORT ARM, OMRON #A-20GV22-B7-K
S5	1		SWITCH, ROTARY, SHORTING, 3 POL, 4 POS, MOUSER # 10WW034
S6	1	10-402	SWITCH, ROCKER, DPDT, CARLINGSWITCH # 62115929-0-0-V
S7	1	10-302	SWITCH, TOGGLE, SPDT, 3A, 125V, EATON/CUTLER-HAMMER #7582K6
S8	1	10-514	SWITCH, ROTARY, 6 POL, 2 POS, MOUSER # 10YX062
SG1,2	2	06-205	SPARK GAP, 90V, CP CLARE # CG90L
T1	1	25-110	TRANSFORMER, VARIABLE, SUPERIOR TYPE 126
T2	1	T080	TRANSFORMER, CURRENT, HVI # 080

T3	1	T143A	TRANSFORMER, AUTO STEP-DOWN, 230/115, 2.5 kVA, HVI # 143A
TM	1	16-065	TIMER, DIGITAL, OMRON # H5CR-B W/PANEL MOUNT
HV TNK	1	84-271	TANK, HIGH VOLTAGE 50/210 kVac , HV # ALT-1064S
<b>PCB-001-PFT2</b>		<b>82-265</b>	<b>VOLT METER PCB</b>
C1	1	03-065	CAPACITOR, ELECTROLYTIC, RADIAL LEADS, 470µF, 50 Vdc, MOUSER # 140-XRL50V470
D1	1	04-025	DIODE, 1N4007A
D2	1	04-415	DIODE, FULL WAVE BRIDGE, 1.5A, 1kVdc, MOUSER # 583-RB157
J1	1	07-136	CONNECTOR, HEADER, 8 PIN, .1" SPACING, MOLEX # 22-23-2081
NE1,2	2	15-114	NEON LAMP, #NE2
P1	1	07-120	CONNECTOR, CABLE, 8 PIN, .1" SPACING, MOLEX # 22-01-2087
	8	07-104	CONNECTOR PINS, .1" SPACING, MOLEX # 08-50-0114
PCB	1	14-001	PRINTED CIRCUIT BOARD, HVI # PCB-001
R1	1	01-152	RESISTOR, METAL FILM, 0.25W, 165K, 1%
R2	1	01-156	RESISTOR, METAL FILM, 0.25W, 249K, 1%
R3	1	01-074	RESISTOR, METAL FILM, 0.25W, 1.5K, 1%
R4	1	02-012	RESISTOR, POTENTIOMETER, 0.25W, 1K, MOUSER # 569-25PR-1K
R5,6	2	01-310	RESISTOR, CARBON FILM, 1W, 1K, 5%
RY1	1	11-110	RELAY, PCB MOUNT, SPDT, 24 Vdc COIL, P&B # T70L5D131-24
<b>PCB-007a</b>		<b>82-263</b>	<b>AC OVERLOAD, REV A</b>
C1	1	03-097	CAPACITOR, POLYESTER, .068µF, 250 Vdc, MOUSER # 1430-1684
D2	1	04-415	DIODE, FULL WAVE BRIDGE, 1.5A, 1kVdc, MOUSER # 583-RB157
PCB	1	14-007	PRINTED CIRCUIT BOARD, HVI # PCB-007a
J1	1	07-130	CONNECTOR, PCB HEADER, 5 PIN, .1" SPACING, MOLEX # 22-23-2051
P1	1	07-114	CONNECTOR, CABLE, 5 PIN, .1" SPACING, MOLEX # 22-01-2057
	5	07-104	CONNECTOR PINS, .1" SPACING, MOLEX # 08-50-0114
R1	1	02-016	RESISTOR, POTENTIOMETER, .250 W, 5K, MOUSER # 569-25PR-5K
R2-4	3	01-332	RESISTOR, CARBON FILM, 2W, 51 OHM, 5%
RY1	1	11-110	RELAY, PCB MOUNT, SPDT, 24 Vdc COIL, P&B # T70L5D131-24
SG1	1	06-205	SPARK GAP, 90V, CP CLARE # CG90L
<b>MISC.</b>			
	1	23-109	KNOB, SKIRTED, DIAL, MOUSER # 45KN021
	2	23-119	KNOB, SKIRTED, POINTER, ALCO # PKD-70B-1/4
	1	23-105	KNOB, SKIRTED, 1-10, ALCO # PKD-70B-10-1/4
	2		TEST LEAD, GROUND, BLACK, 20 FT. WITH CLIP AND BOOT
	1	08-893	TERMINAL BLOCK, 10 POS., # 12-141
	1		U-WRAP, HV # PFT-1001D, REV I
	1		SCHEMATIC, WIRING, HVI # ALT-1081S, REVA
	1		PANEL, CONTROL, HVI # ALT-1018D, REV 0
	20ft.	22-508	CABLE, 3 COND., 12 AWG
	25ft.		COAXIAL RETURN LEAD, RG58/U WITH CLIP AND BOOT
	1		LABEL, CAP CANCEL, HVI # ALT-1032D
	1	88-001	TEST LEAD, HIGH VOLTAGE, RED, 20 FT. WITH CLIP AND BOOT
	2	88-003	GROUND LEAD, 20FT, YELLOW/GREEN, 10AWG
<b>PCB-001-CM</b>		<b>82-261</b>	<b>CURRENT METER PCB</b>
D1	1	04-025	DIODE, 1N4007A
J1	1	07-136	CONNECTOR, PCB HEADER, 8 PIN, .1" SPACING, MOLEX # 22-23-2081
P1	1	07-120	CONNECTOR, CABLE, 8 PIN, .1" SPACING, MOLEX # 22-01-2087
	8	07-104	CONNECTOR PINS, .1" SPACING, MOLEX # 08-50-0114
PCB	1		PRINTED CIRCUIT BOARD, HVI # PCB-001
R5	1	01-310	RESISTOR, CARBON FILM, 1W, 1K, 5%
RY1	1	11-110	RELAY, PCB MOUNT, SPDT, 24 Vdc COIL, P&B # T70L5D131-24
<b>PCB-008b</b>		<b>82-264</b>	<b>CAPACITIVE CURRENT CANCEL</b>
C0	1	03-100	CAPACITOR, POLYPROPELENE, 0.1, 250V, MOUSER #1431-2104K
C1,2	2	03-115	CAPACITOR, POLYPROPELENE, 0.01, 400V, MOUSER #1431-4103K
C3-5	3	03-085	CAPACITOR, CERAMIC DISC, 0.01, 100Vdc, MOUSER #140-50Z5103M
C6	1		NOT USED
C7,8	2	03-060	CAPACITOR, ELECTROLYTIC, RADIAL LEADS, 100µF, 50 Vdc, MOUSER # 140-XRL50V100

C9	1	03-045	CAPACITOR, ELECTROLYTIC, RADIAL LEADS, 4.7μF, 50Vdc, MOUSER # 140-XRL50V4.7
C10	1	03-092	CAPACITOR, CERAMIC DISC, 0.1, 50Vdc, MOUSER #140-CD50Q9-104Z
D1-6,9,10	8	04-010	DIODE, SWITCHING, 1N4148
D7,8	2	04-025	DIODE, GENERAL PURPOSE, 1000V, 1 AMP, 1N4007A
J1	1	07-140	CONNECTOR, PCB HEADER, 14 PIN, .1" SPACING, MOLEX # 22-23-2141
J2	1	07-130	CONNECTOR, PCB HEADER, 5 PIN, .1" SPACING, MOLEX # 22-23-2051
MOV1,2	2	06-207	METAL OXIDE VARISTOR, # V130LA10A
P1	1	07-124	CONNECTOR, CABLE, 14 PIN, .1" SPACING, MOLEX # 22-01-2147
P2	1	07-114	CONNECTOR, CABLE, 5 PIN, .1" SPACING, MOLEX # 22-01-2057
	19	07-104	CONNECTOR PINS, .1" SPACING, MOLEX # 08-50-0114
PCB	1		PRINTED CIRCUIT BOARD, HVI # PCB-008a
Q1	1	05-345	VOLTAGE REGULATOR, +15V, # MC78M15C
Q2	1	05-340	VOLTAGE REGULATOR, -15V, # MC79M15C
R0	2	01-060	RESISTOR, METAL FILM, 0.25W, 1K, 1%
R1,2	2	01-152	RESISTOR, METAL FILM, 0.25W, 165K, 1%
R3,4	2	02-120	RESISTOR, POTENTIOMETER, 0.50 W, 1M, 20T, MOUSER # 72-T93YB-1M
R5,7	2	01-150	RESISTOR, METAL FILM, 0.25W, 100K, 1%
R6	1		JUMPER
R8,22	2	01-100	RESISTOR, METAL FILM, 0.25W, 10K, 1%
R9a	1	01-140	RESISTOR, METAL FILM, 0.25W, 53.6K, 1%
R9b	1	01-090	RESISTOR, METAL FILM, 0.25W, 4.99K, 1%
R10	1	02-102	RESISTOR, POTENTIOMETER, 0.50 W, 1K, 20T, MOUSER # 72-T93YB-1K
R11	1	01-082	RESISTOR, METAL FILM, 0.25W, 3.01K, 1%
R12	1	01-060	RESISTOR, METAL FILM, 0.25W, 1K, 1%
R13-15	3	01-150	RESISTOR, METAL FILM, 0.25W, 100K, 1%
R16	1	01-146	RESISTOR, METAL FILM, 0.25W, 71.5K, 1%
R17,20	2	02-114	RESISTOR, POTENTIOMETER, 0.50 W, 50K, 20T, MOUSER # 72-T93YB-50K
R18,23,24	3	01-150	RESISTOR, METAL FILM, 0.25W, 100K, 1%
R19	1	01-100	RESISTOR, METAL FILM, 0.25W, 10K, 1%
R25	1	01-108	RESISTOR, METAL FILM, 0.25W, 16K, 1%
R26	1	01-156	RESISTOR, METAL FILM, 0.25W, 249K, 1%
R27	1	02-114	RESISTOR, POTENTIOMETER, 0.50 W, 50K, 20T, MOUSER # 72-T93YB-50K
R28,29	2	01-220	RESISTOR, METAL FILM, 0.5W, 200Ω, 1%
R30	1	01-212	RESISTOR, METAL FILM, 0.5W, 100Ω, 1%
R31	1	02-118	RESISTOR, POTENTIOMETER, 0.50 W, 100K, 20T, MOUSER # 72-T93YB-100K
R32	1	01-162	RESISTOR, METAL FILM, 0.25W, 300K, 1%
R33	1	01-100	RESISTOR, METAL FILM, 0.25W, 10K, 1%
T1	1	25-319	TRANSFORMER, MAGNETEK # VPP28-180
U1-4	4	05-205	AMPLIFIER, OPERATIONAL, # OP-07DP
	4	05-265	IC SOCKET, 8 PIN DIP

## HV TANK

	1	<b>84-271</b>	ALT-210/50 HIGH VOLTAGE TANK, SCHEMATIC # ALT-1064S
MOV1	1	06-207	METEL OXIDE VARISTOR, # V130LA10A
MOV2	1	06-210	METEL OXIDE VARISTOR, # V250LA10A
NE1-4	4	15-114	NEON BULB, # NE2
J1	1	07-010	CONNECTOR, BULKHEAD, CIRCULAR, 7PIN, AMPHENOL # 97-3102E-20-15P
R1-8	9	01-440	RESISTOR, METAL FILM, 12.5W, 60M, 1%, EBG # SSX103-60M
SG1	1	06-205	SPARK GAP, 90V, CP CLARE # CG90L
T1	1	T288a	TRANSFORMER, HIGH VOLTAGE, HVI # 288A, 120 MIL GAP, <b>WITH 50kV TAP</b>
T2	1	T289	TRANSFORMER, HIGH VOLTAGE, HVI # 289
T3	1	T290	TRANSFORMER, HIGH VOLTAGE, HVI # 290
X1,2	2	09-130	TERMINALS, FEEDTHROUGH, 10-32 THREAD, LUNDEY # 375-T20
X3-5	3	09-100	TERMINALS, FEEDTHROUGH, 6-32 THREAD, LUNDEY # 250-S-T-15
	1	08-821	TOROID, 18 X 3 ALUM
	1	40-616	CYLINDER, 10 DIA. X 21 TALL I.D., 1 IN. FLANGE EACH END
	1	34-261	BASE ASSEMBLY, HVI # ALT-1003D
	1	08-833	BALL, CORONA, 1" BRASS, ¼-20 THREAD



QTY	DESCRIPTION	PART NO.	MATL OR NOTE	ITEM
1	SCHEMATIC			
1	ALT-210/50			
1	AERIAL LIFT TESTER			
1	HV SECTION			

  

MATL	ALT-210/50 THK	REV.
FINISH	ALT-1064S B	
PROJECTIONS	SCALE	DATE
31/24	1/20	1/03

REV.	DATE	BY
1	1/03	1/03

PCB-008C  
CAPACITIVE CANCEL  
CIRCUIT

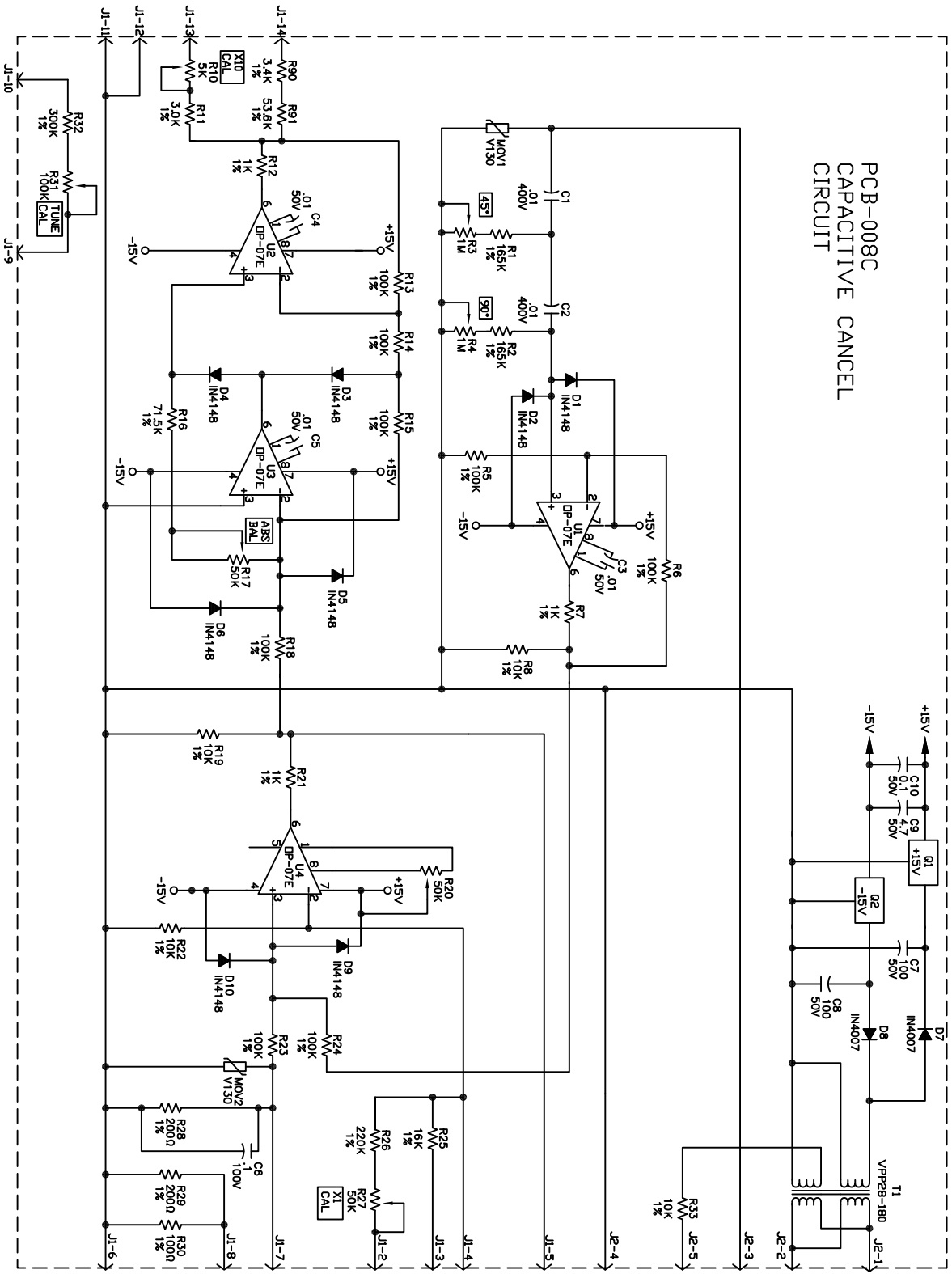

QTY	DESCRIPTION	PART NO.	MATL OR NOTE	REQD
	SCHEMATIC			
	PCB			
	AC CURRENT			
	CAP CANCEL			

MATL	FINISH	FUNCTIONS	DATE	BY	CHKD	DATE	BY

DESIGNER	DATE	BY	CHKD	DATE

REV. NO.	DATE	BY	CHKD	DATE
001	10/28	JHW	JHW	10/28

REV. NO.	DATE	BY	CHKD	DATE
001	10/28	JHW	JHW	10/28

REV. NO.	DATE	BY	CHKD	DATE
001	10/28	JHW	JHW	10/28



HWI  
3/82929279

